

EE 330

Lecture 3

- Integrated Circuit Design Flow
- Basic Concepts
 - Feature Sizes
 - Reliability

Review from last lecture:

Moore's Law

(from Wikipedia)

Moore's law is the empirical observation that the complexity of integrated circuits, with respect to minimum component cost, doubles every 24 months^[1]. It is attributed to Gordon E. Moore^[2], a co-founder of Intel.

- Observation, not a physical law
- Often misinterpreted or generalized
- Many say it has been dead for several years
- Many say it will continue for a long while
- Not intended to be a long-term prophecy about trends in the semiconductor field
- Something a reporter can always comment about when they have nothing to say!

Device scaling, device count, circuit complexity, device cost, ... in leading-edge processes will continue to dramatically improve (probably nearly geometrically with a time constant of around 2 years) for the foreseeable future !!

Review from last lecture:

Field Effect Transistors

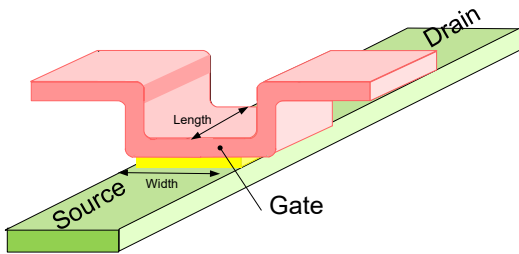

Planar MOSFET (LOCOS)

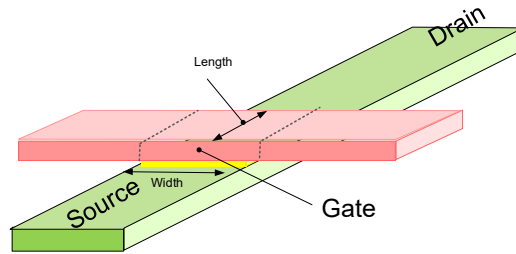

Planar MOSFET (STI)

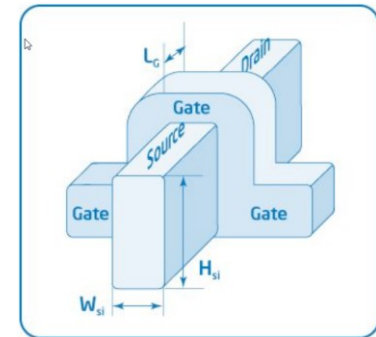

FinFET
Tri-Gate
Dielectric not shown

Review from last lecture:

Feature Size

The feature size of a process generally corresponds to the minimum lateral dimensions of the transistors that can be fabricated in the process

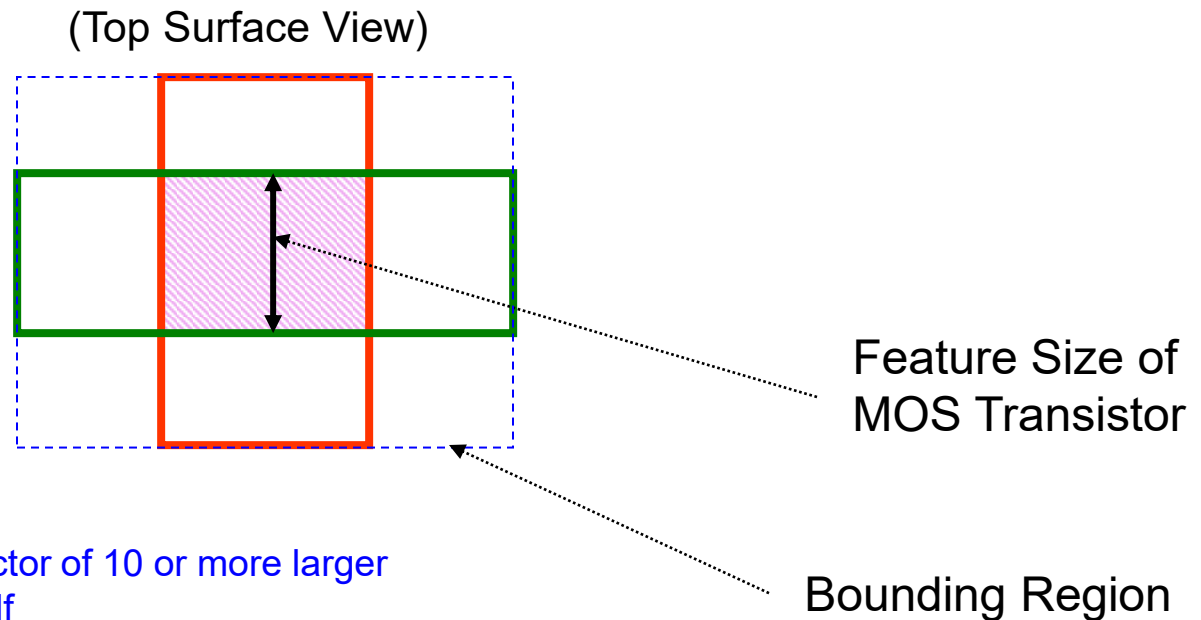

- Bounding region often a factor of 10 or more larger than area of transistor itself
- This along with interconnect requirements and sizing requirements throughout the circuit create an area overhead factor of 10x to 100x

Considerable Cash Flow Inherent in the Semiconductor Industry

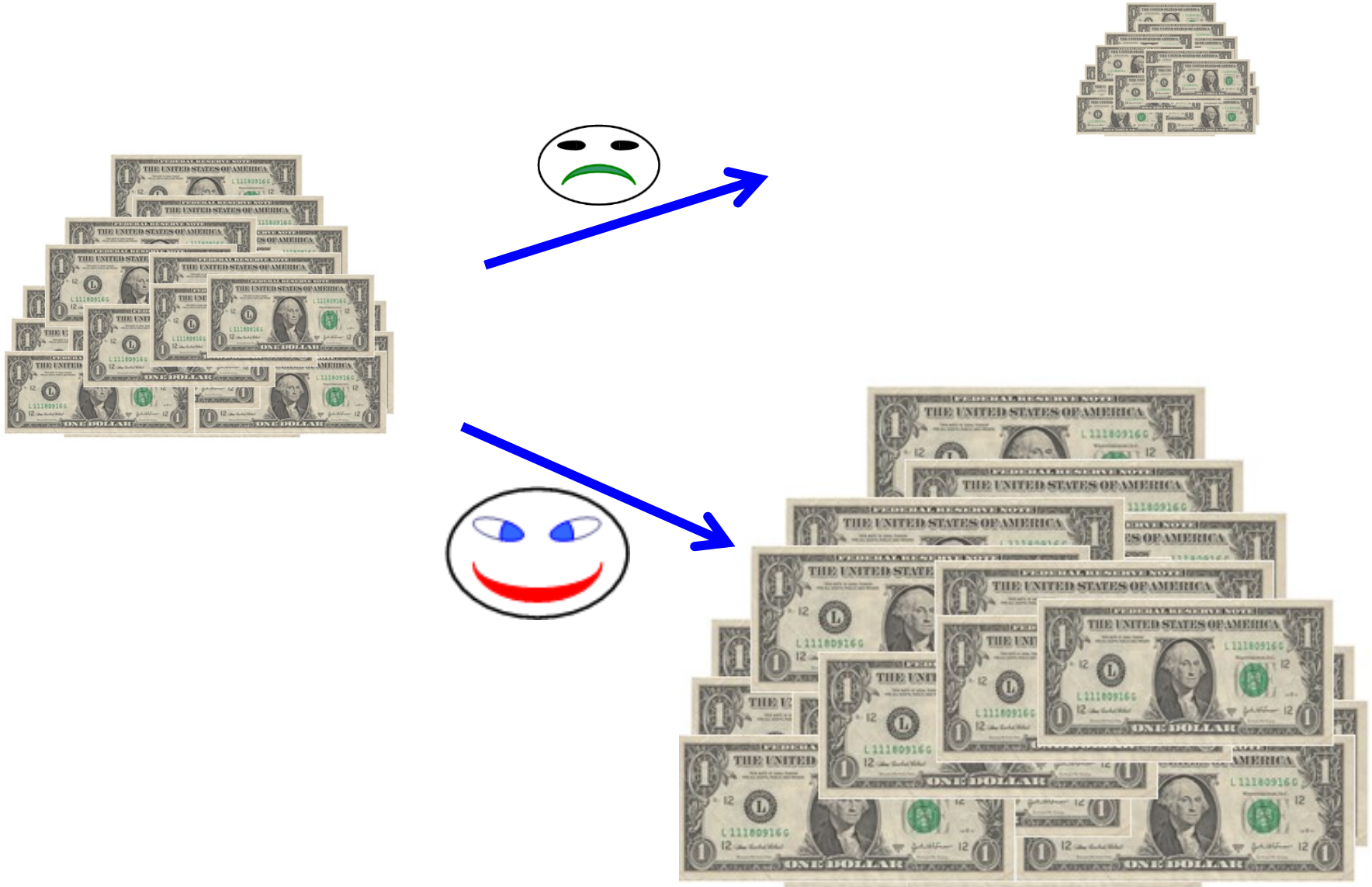

Essentially All Activities Driven by Economic Considerations



- Many Designs Cost Tens of Millions of Dollars
- Mask Set and Production of New Circuit Approaching \$2 Million
- New Foundries Costs Approaching \$10 Billion (few players in World can compete)
- Many Companies Now Contract Fabrication (Fabless Semiconductor Companies)
- Time to Market is Usually Critical
- Single Design Error Often Causes Months of Delay and Requires New Mask Set
- Potential Rewards in Semiconductor Industry are Very High

Will emphasize economic considerations throughout this course

Understanding of the Big Picture is Critical



Solving Design Problems can be Challenging

Be sure to solve the right problem !



How can complex circuits with a very large number of transistors be efficiently designed with low probability of error?

 Many designers often work on a single design

 Single error in reasoning, in circuit design, or in implementing circuit on silicon generally results in failure

- Design costs and fabrication costs for test circuits are very high
 - Design costs for even rather routine circuits often a few million dollars and some much more
 - Masks and processing for state of the art processes often between \$1M and \$2M
- Although much re-use is common on many designs, considerable new circuits that have never been designed or tested are often required
- Time to market critical – missing a deadline by even a week or two may kill the market potential

Single Errors Usually Cause Circuit Failure

- How many components were typical of lab experiments in EE 201 and EE 230?
- Has anyone ever made an error in the laboratory of these courses ? (wrong circuit, incomplete understanding, wrong wiring, wrong component values, imprecise communication, frustration
- How many errors are made in a typical laboratory experiment in these courses?
- How many errors per hour might have occurred?

Single Errors Usually Cause Circuit Failure

Consider an extremely complicated circuit

- with requirements to do things that have never been done before
- with devices that are not completely understood
- that requires several billion transistors
- that requires 200 or more engineers working on a project full-time for 3 years
- with a company investment of many million dollars
- with an expectation that nobody makes a single error

Is this a challenging problem for all involved?

How can complex circuits with a very large number of transistors be efficiently designed with low probability of error?

- CAD tools and CAD-tool environment critical for success today
- Small number of VLSI CAD toolset vendors
- CAD toolset helps the engineer and it is highly unlikely the CAD tools will replace the design engineer
- An emphasis in this course is placed on using toolset to support the design process

CAD Environment for Integrated Circuit Design

- Typical Tool Flow
 - (See Chapter 14 of Text)
- Laboratory Experiments in Course

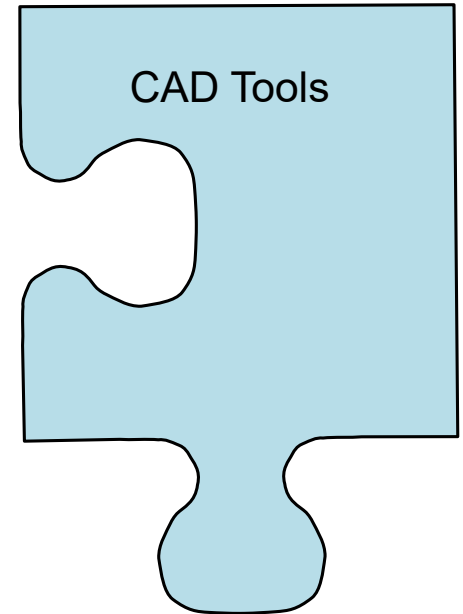

VLSI Design Flow Summary

Analog Flow

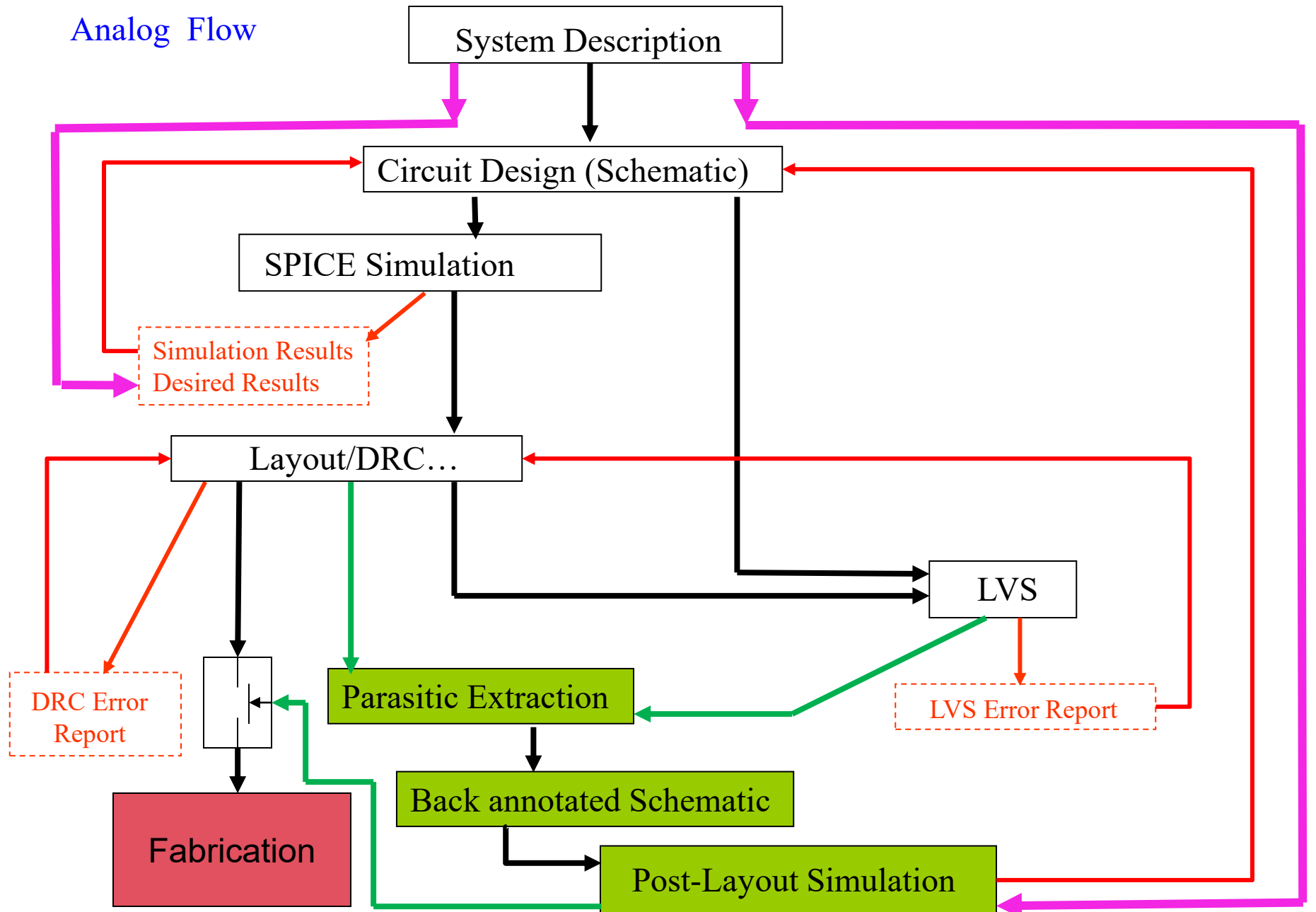

VLSI Design Flow Summary

Analog Flow

System Description

Circuit Design (Schematic)

Schematic Editor

SPICE Simulation

Spectre (or HSPICE)

Simulation Results
Desired Results

Layout/DRC...

Assura DRC

LVS

Assura LVS

LVS Error Report

Assura RCX

Parasitic Extraction

Back annotated Schematic

Spectre (or HSPICE)

Post-Layout Simulation

Fabrication

Cadence
Virtuoso Platform

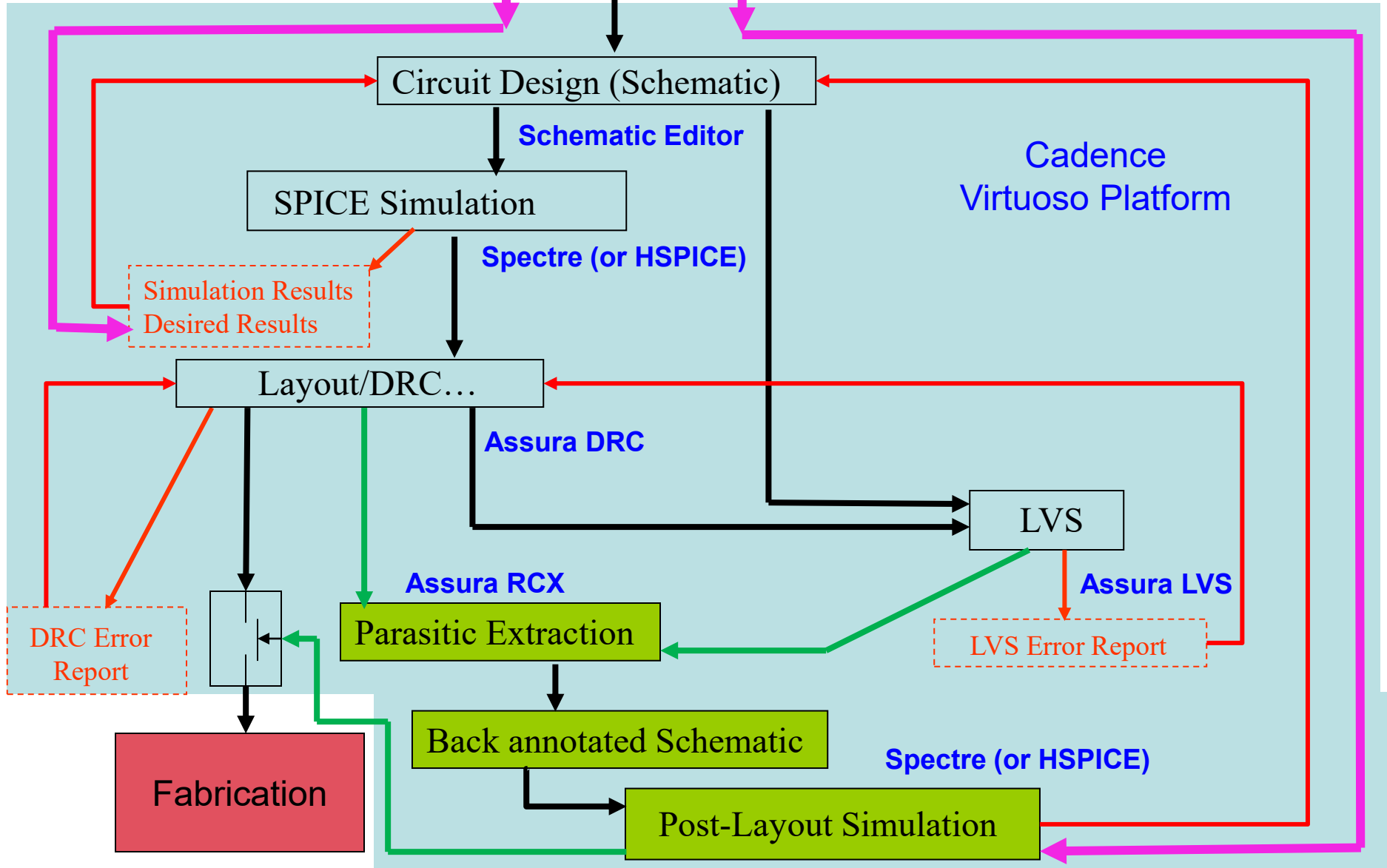

VLSI Design Flow Summary

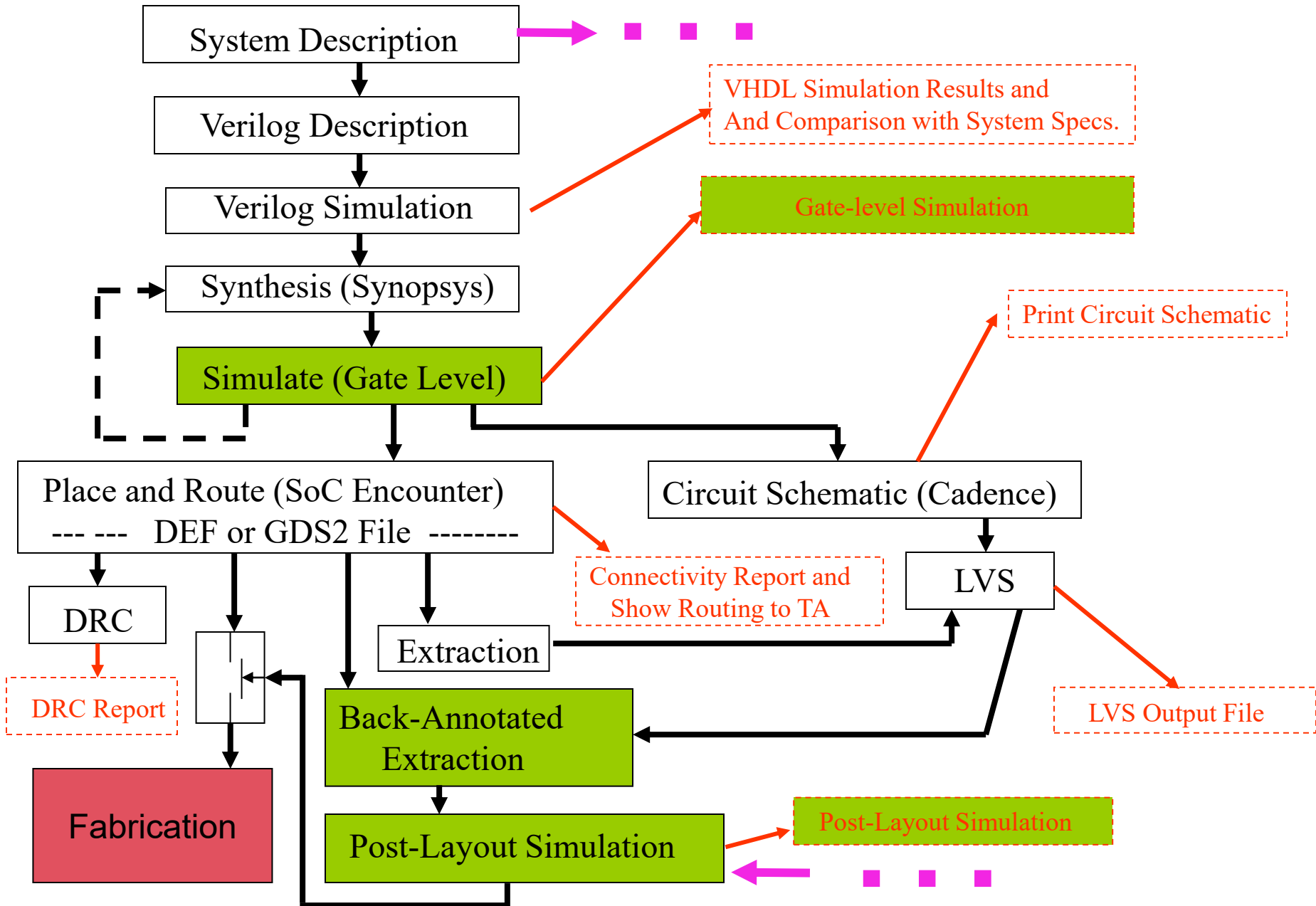

VLSI Design Flow Summary

Digital Flow

Cadence SoC Encounter

Verilog XL

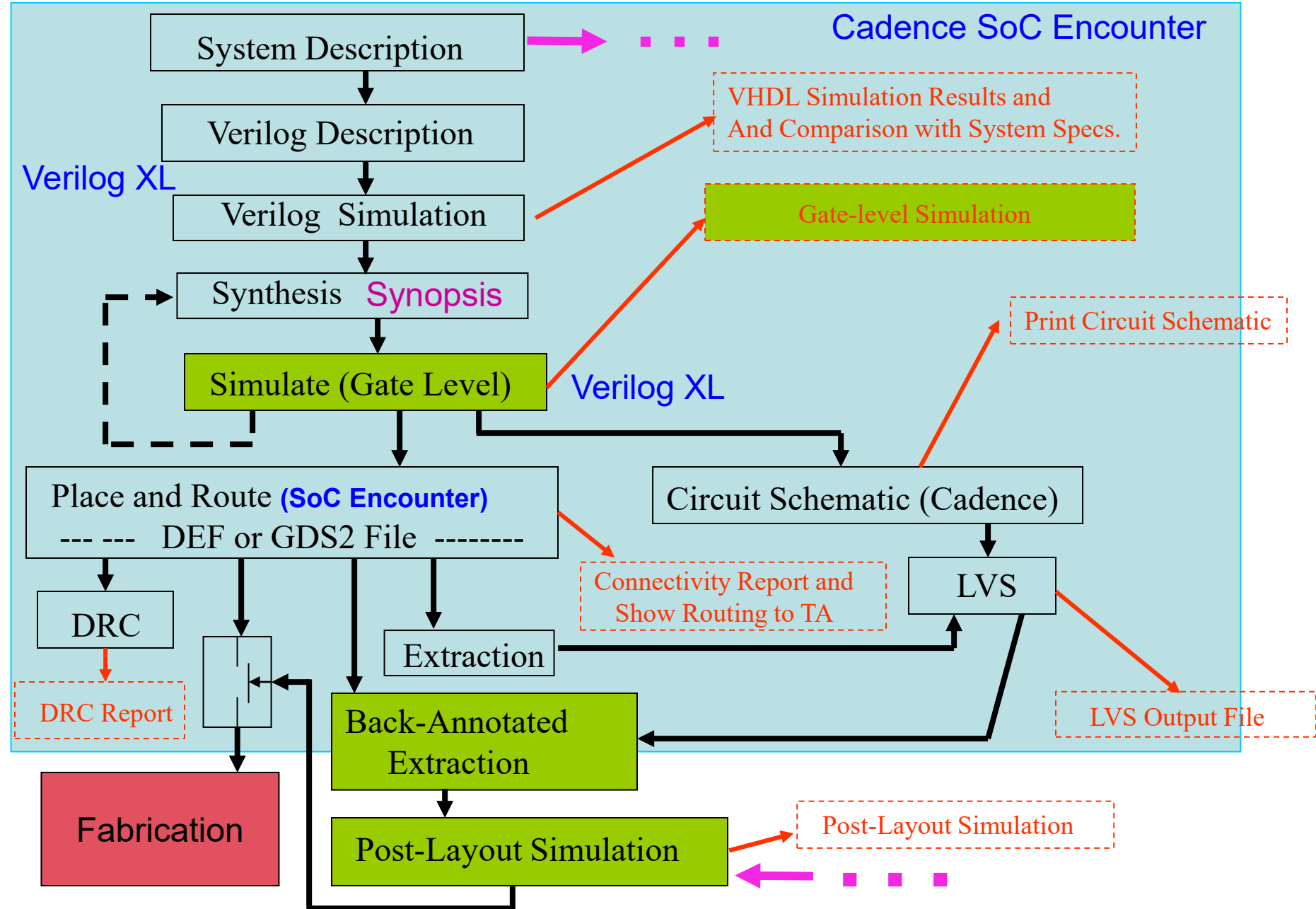

VLSI Design Flow Summary

Mixed Signal Flow (Digital Part)

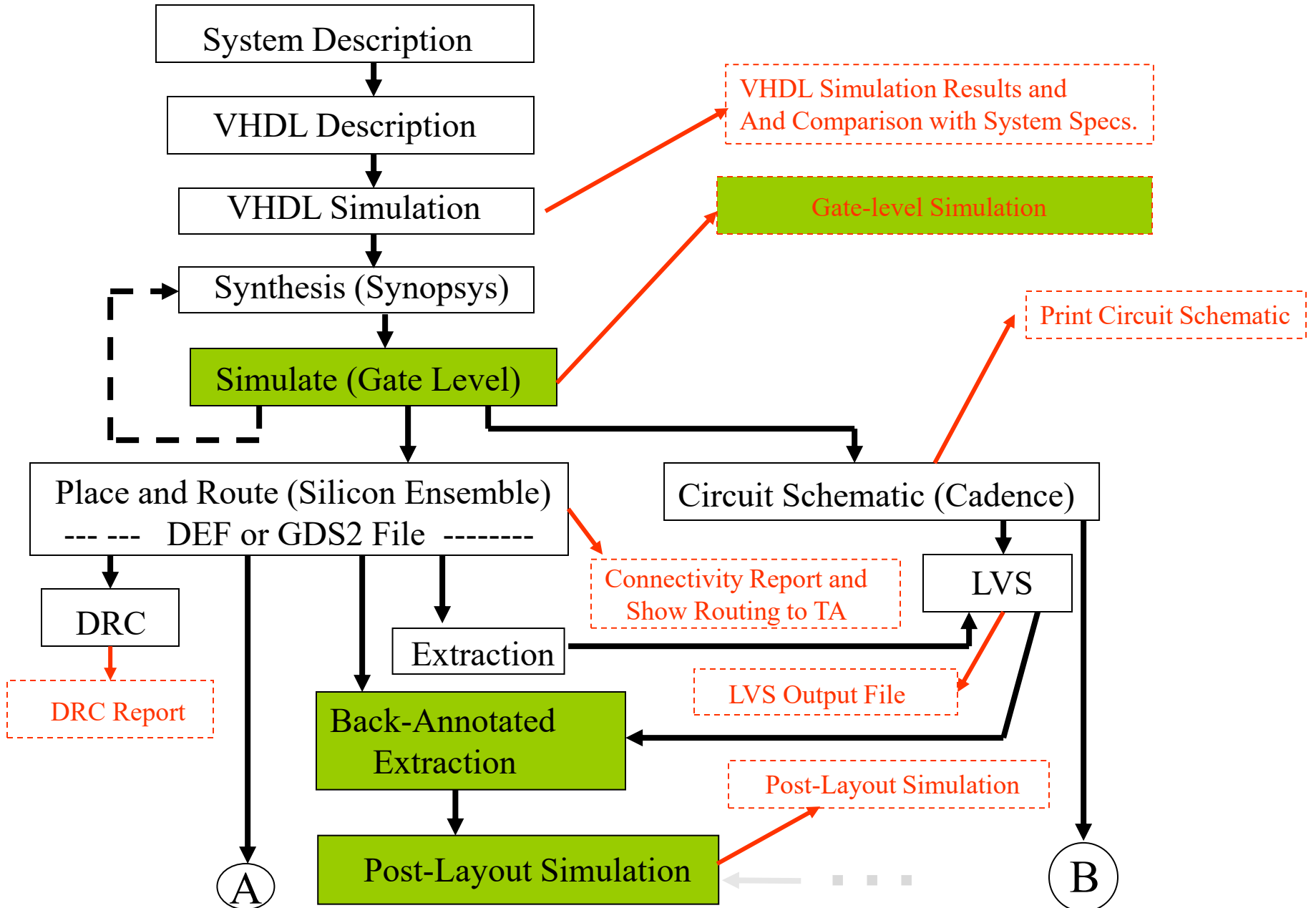

VLSI Design Flow Summary

Mixed - Signal Flow (Analog Part)

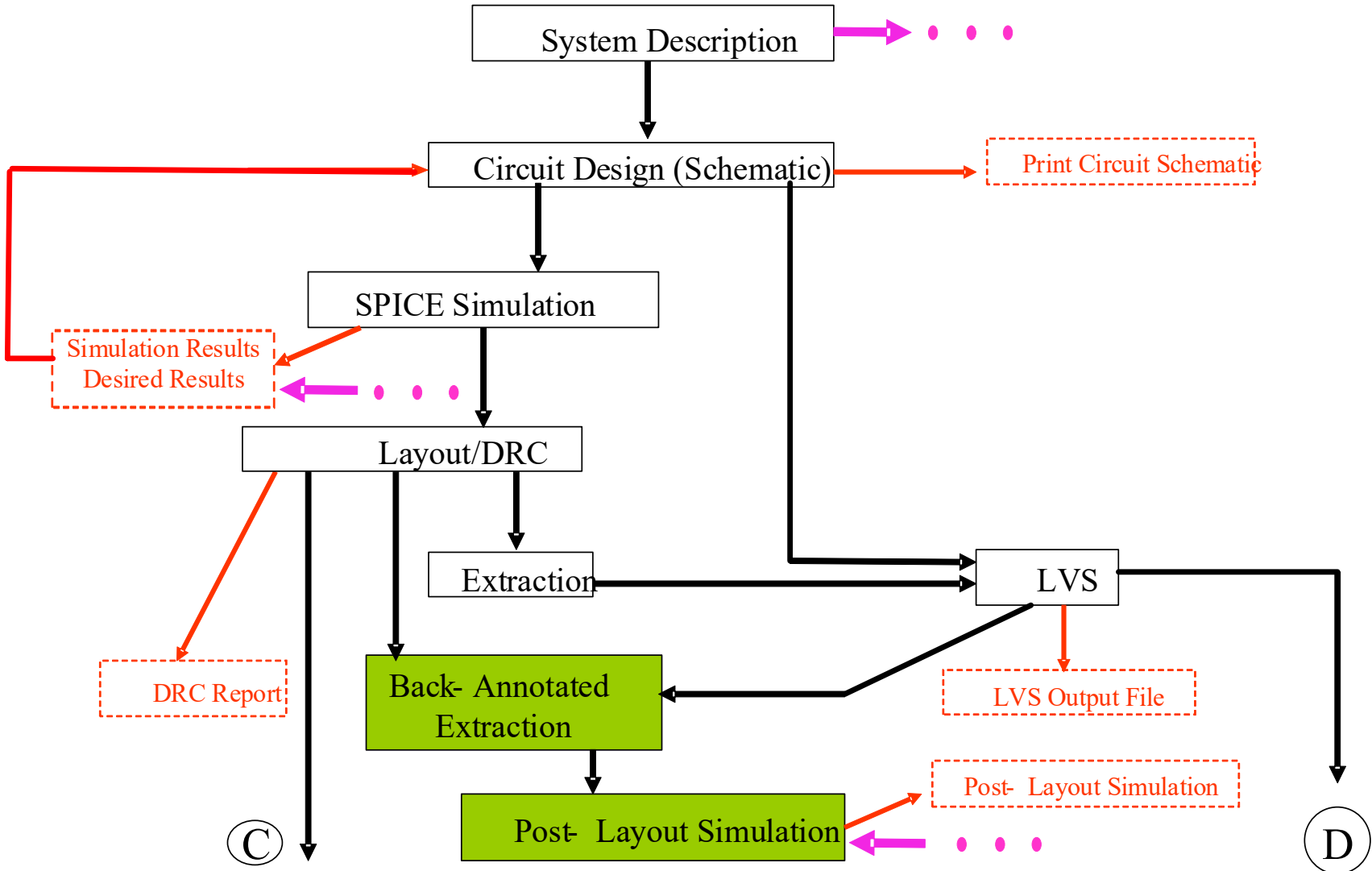

VLSI Design Flow Summary

Mixed-Signal Flow (Analog-Digital Merger)

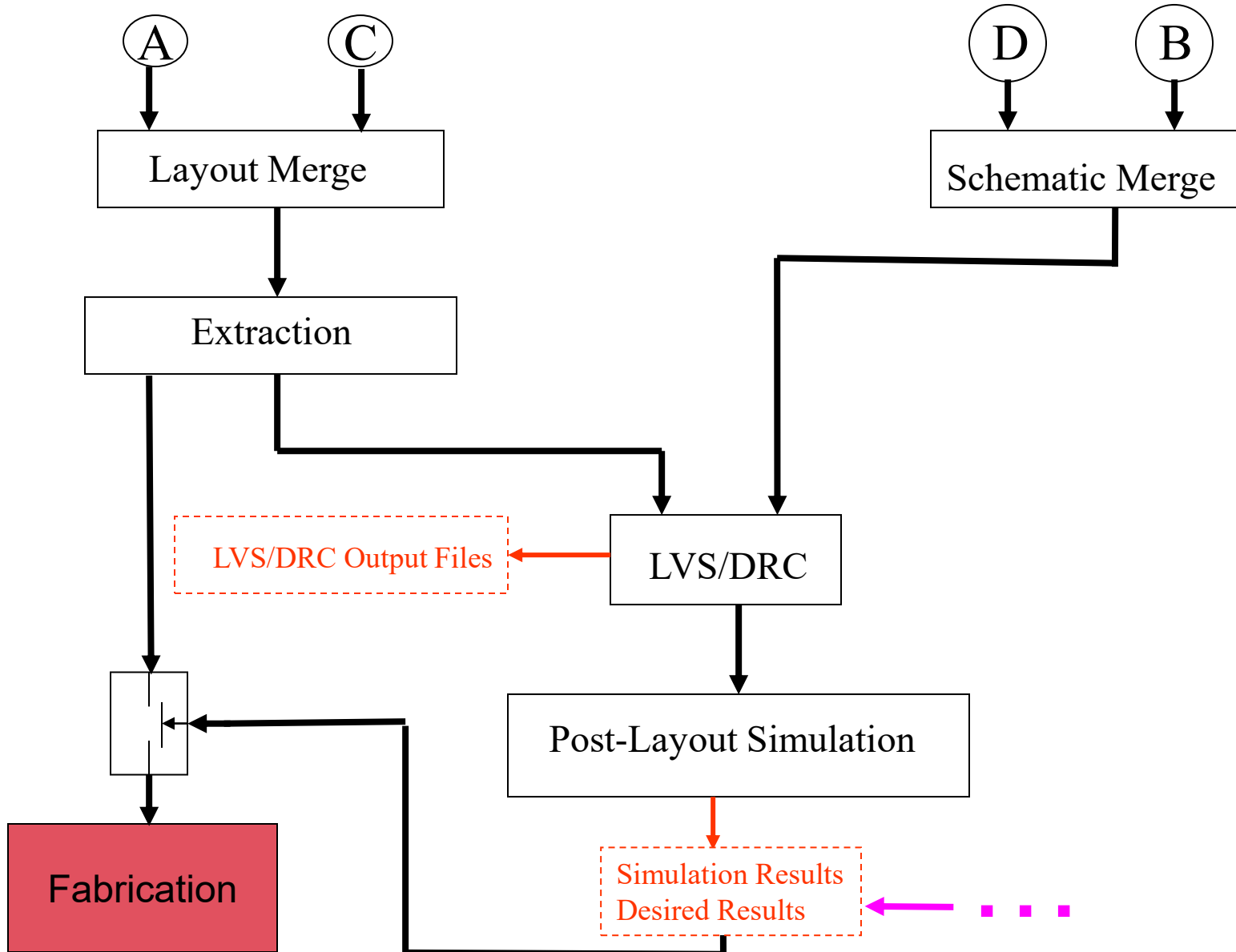

Comments

- The Analog Design Flow is often used for small digital blocks or when particular structure or logic styles are used in digital systems
- Variants of these flows are widely used and often personalized by a given company or for specific classes of circuits

Wafer

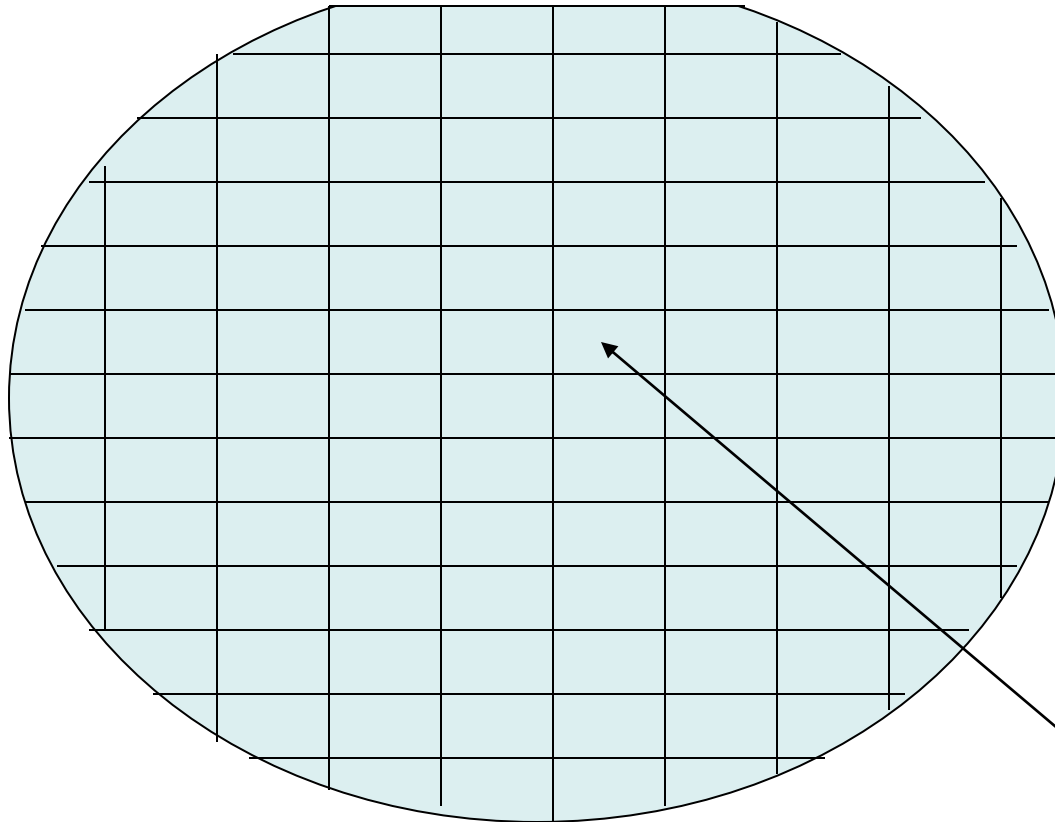

- 6 inches to 18 inches in diameter
- All complete cells ideally identical
- flat edge
- very large number of die if die size is small



die

Why are wafers round?

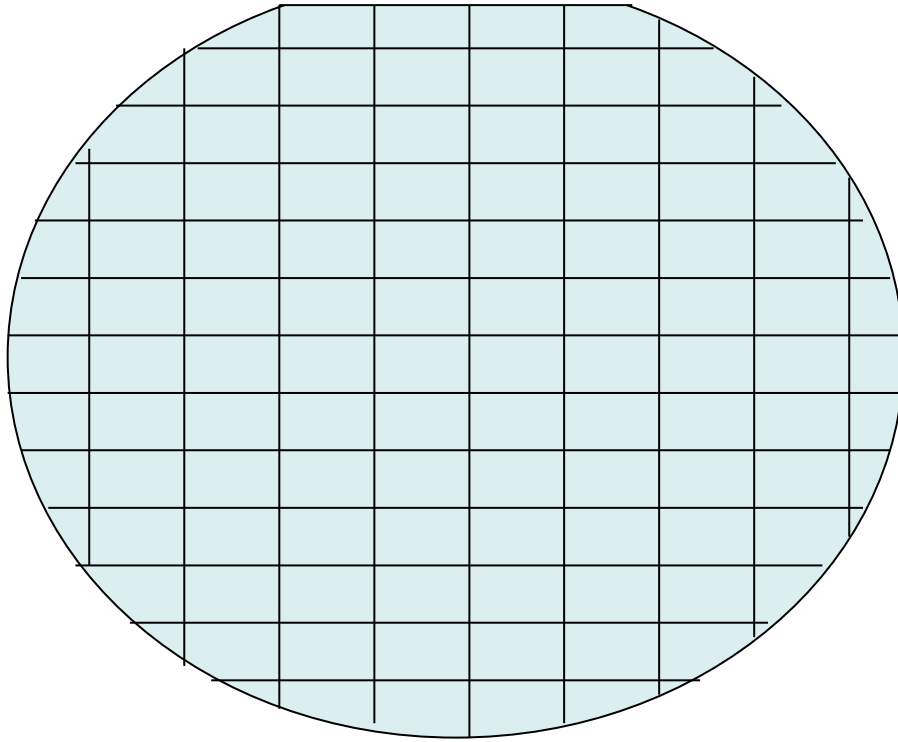

- Ingot spins (rotates) as crystal is being made (dominant reason)
- Edge loss would be larger with rectangular wafers
- Heat is more uniformly distributed during processing
- Size of furnace is smaller for round wafers
- Wafers are spun during application of photoresist and even coatings is critical
- Optics for projection are better near center of image

Feature Size

Feature size is the minimum lateral feature size that can be **reliably** manufactured



Often given as either feature size or pitch

Minimum feature size often identical for different features

Extremely challenging to decrease minimum feature size in a new process

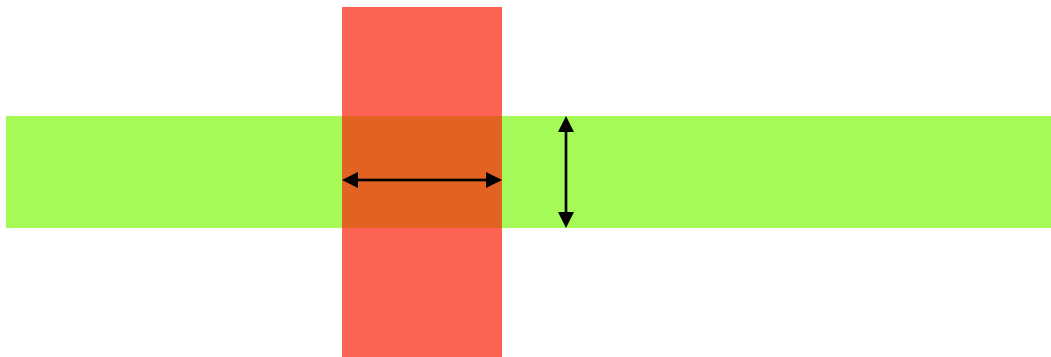

Reliability

Consider the following example:

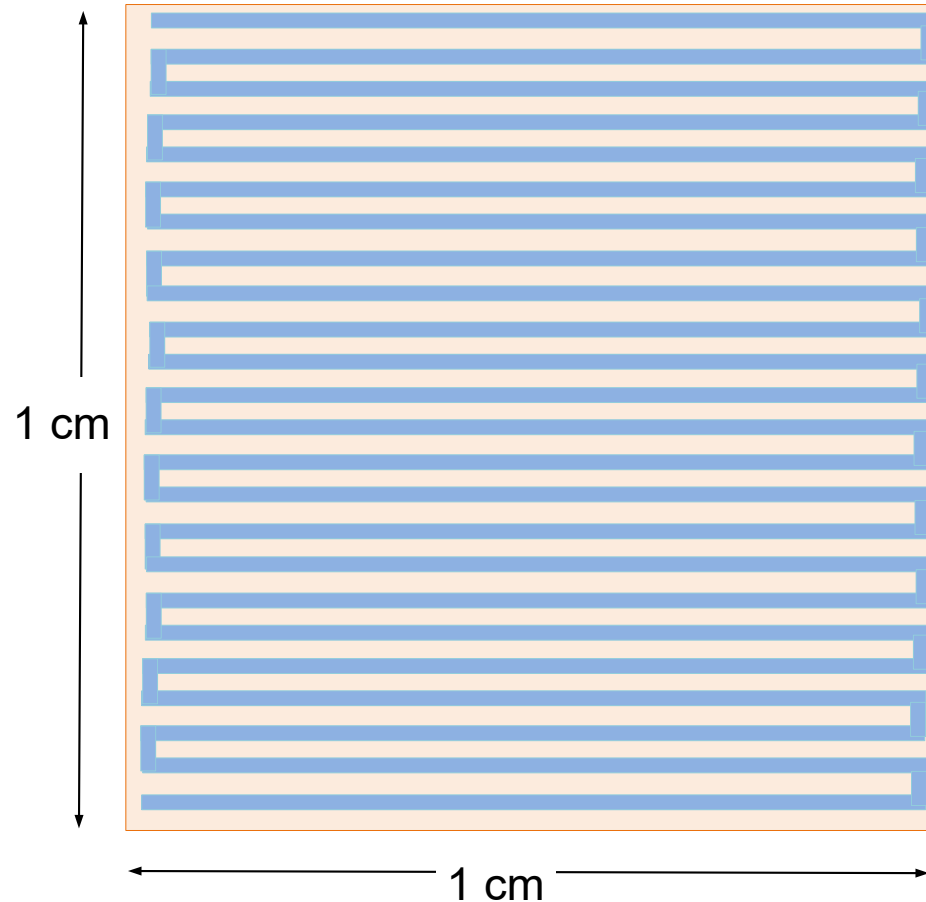

- Die contains only interconnect
- Area 1cm^2
- 5nm process (10nm pitch)
- 10 levels of interconnect (actually pitch will increase in higher levels but ignore that)

How long is the total interconnect?

Reliability

In perspective:

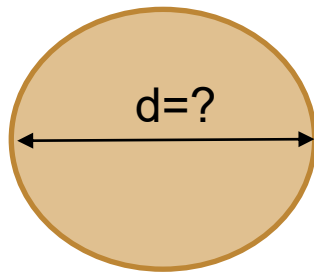

Human Hair



5nm

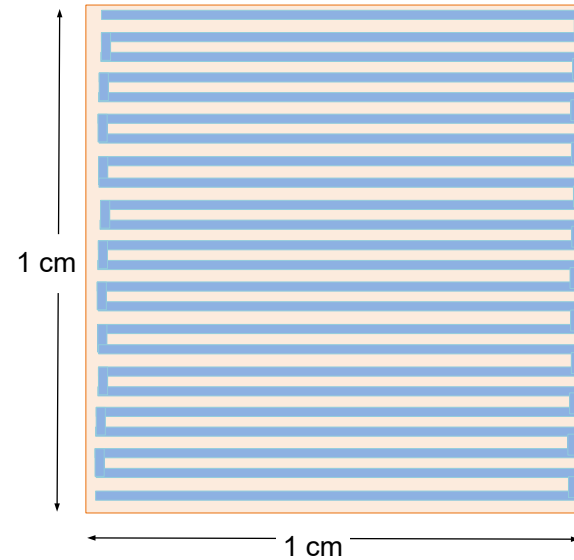

How do these dimensions compare to that of the human hair?

Human Hair Diameter: 18um to 180um

Assume $d=50\mu\text{m}$

$$r = \frac{d}{5\text{nm}} = \frac{50\mu\text{m}}{5\text{nm}} = 10,000$$

- Diameter 10,000 times smaller than the 50um hair
- If interconnect were square (not quite) cross-sectional area would be 100 million times smaller !

Reliability

How long is the total interconnect?

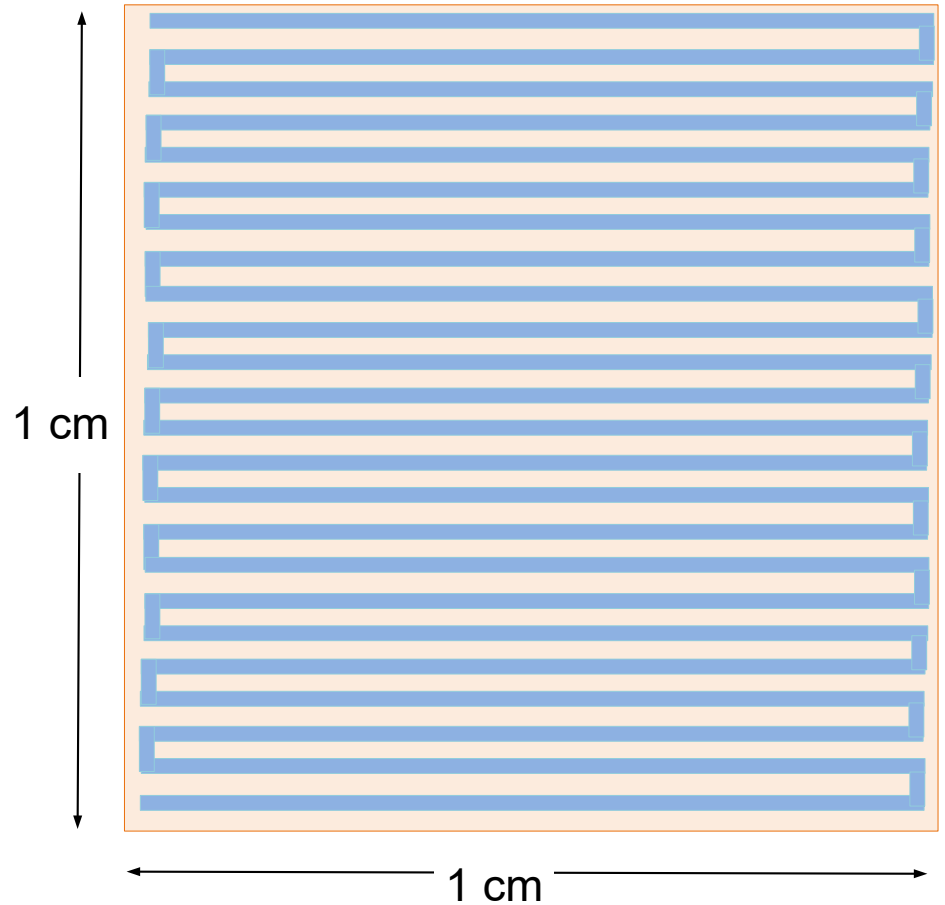

n = number of stripes:

$$n = \frac{1\text{cm}}{5\text{nm} + 5\text{nm}} = \frac{10^{-2}}{10 \times 10^{-9}} = 10^6$$

$$L = n_{\text{LEVELS}} \cdot L_{\text{LEVEL}} = 10 \cdot 10^6 \times 1\text{cm} = 100\text{km}$$

$$L = 62 \text{ miles}$$

Reliability Problems

Desired Features

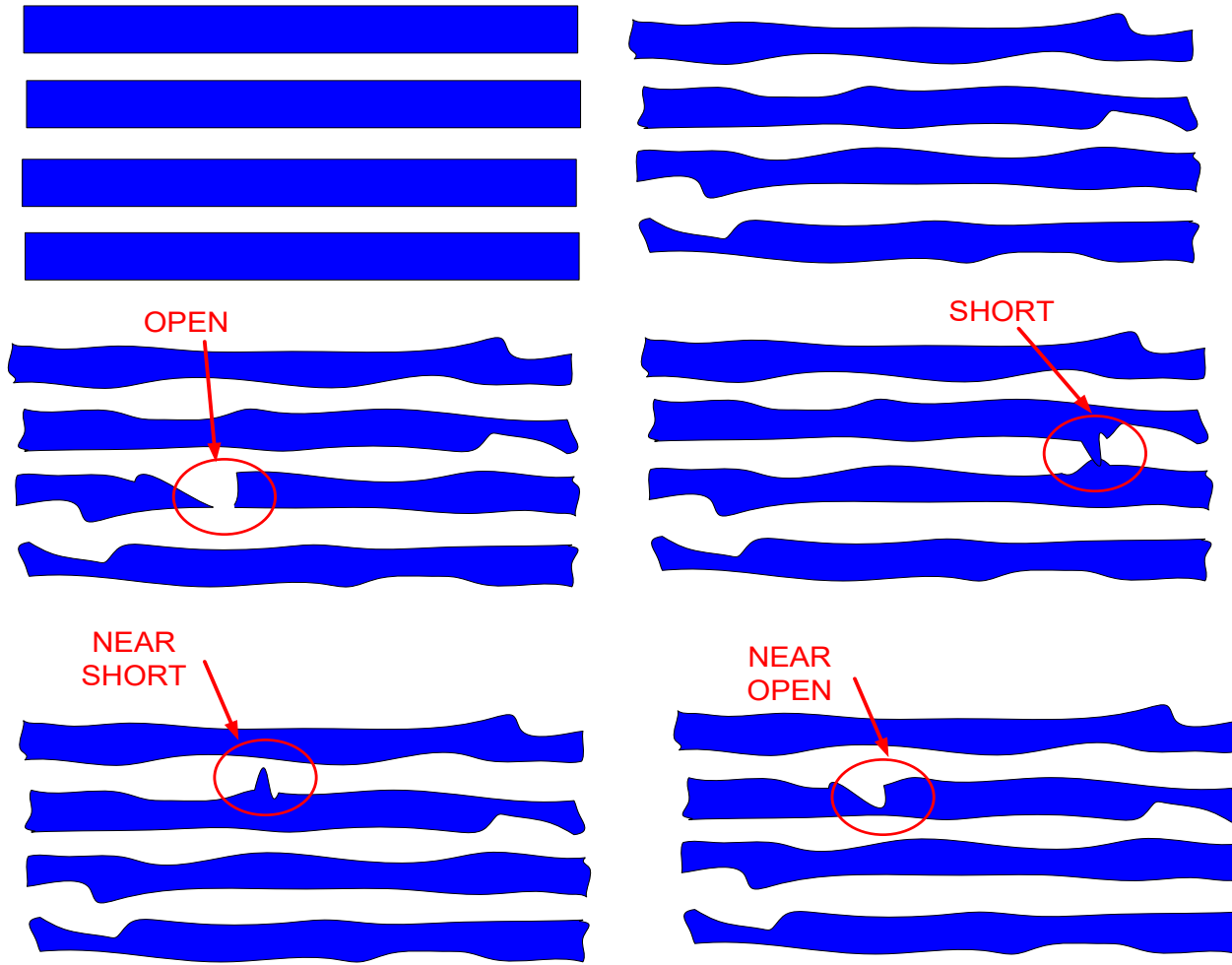

Actual features show some variability (dramatically exaggerated here !!!!)

Reliability Challenges

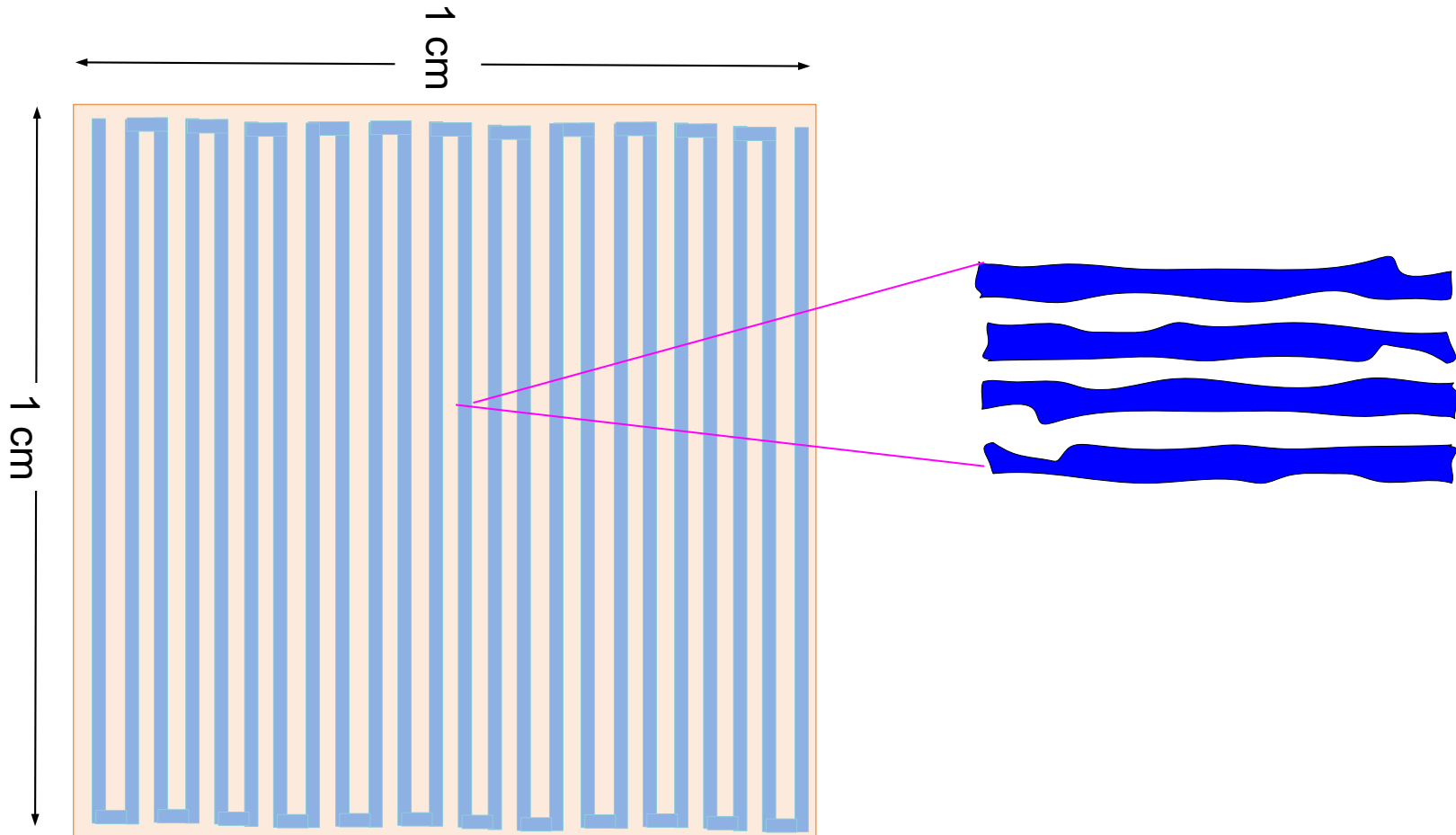

Can not tolerate one defect in 62 miles in these interconnects that are 5nm wide

Feature Size

Feature size is the minimum lateral feature size that can be **reliably** manufactured



Feature size is specified so that there is a very low probability of a single processing defect occurring any place on a die !

SEM Images of Irregularity and/or Defects

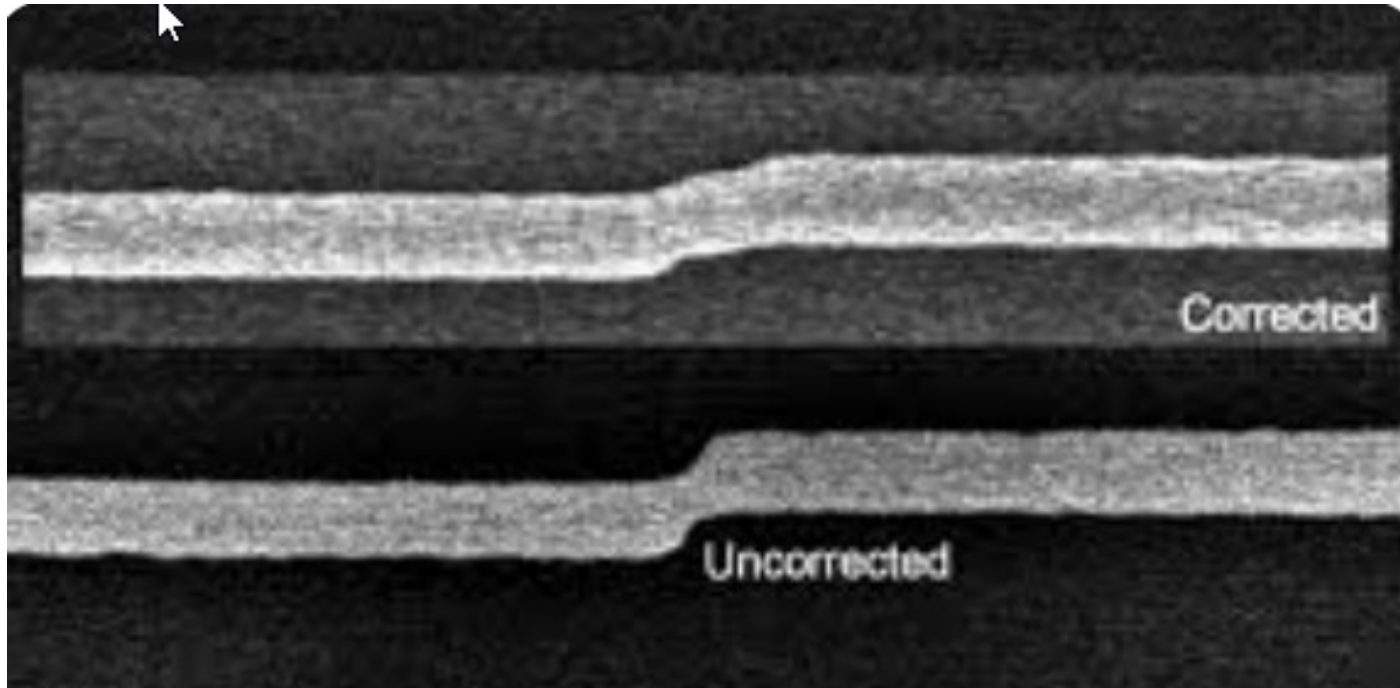

SEM Images of Irregularity and/or Defects

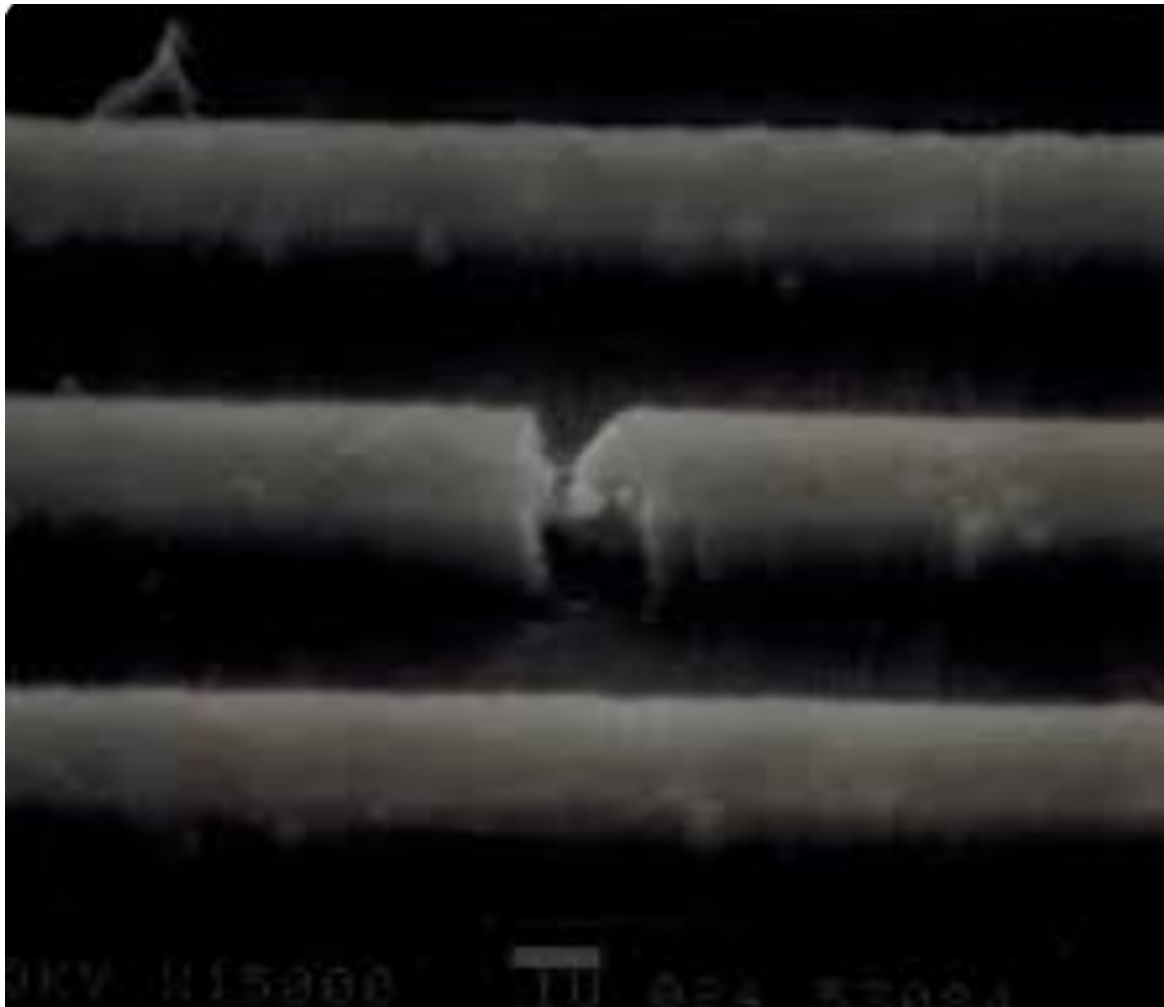

SEM Images of Irregularity and/or Defects

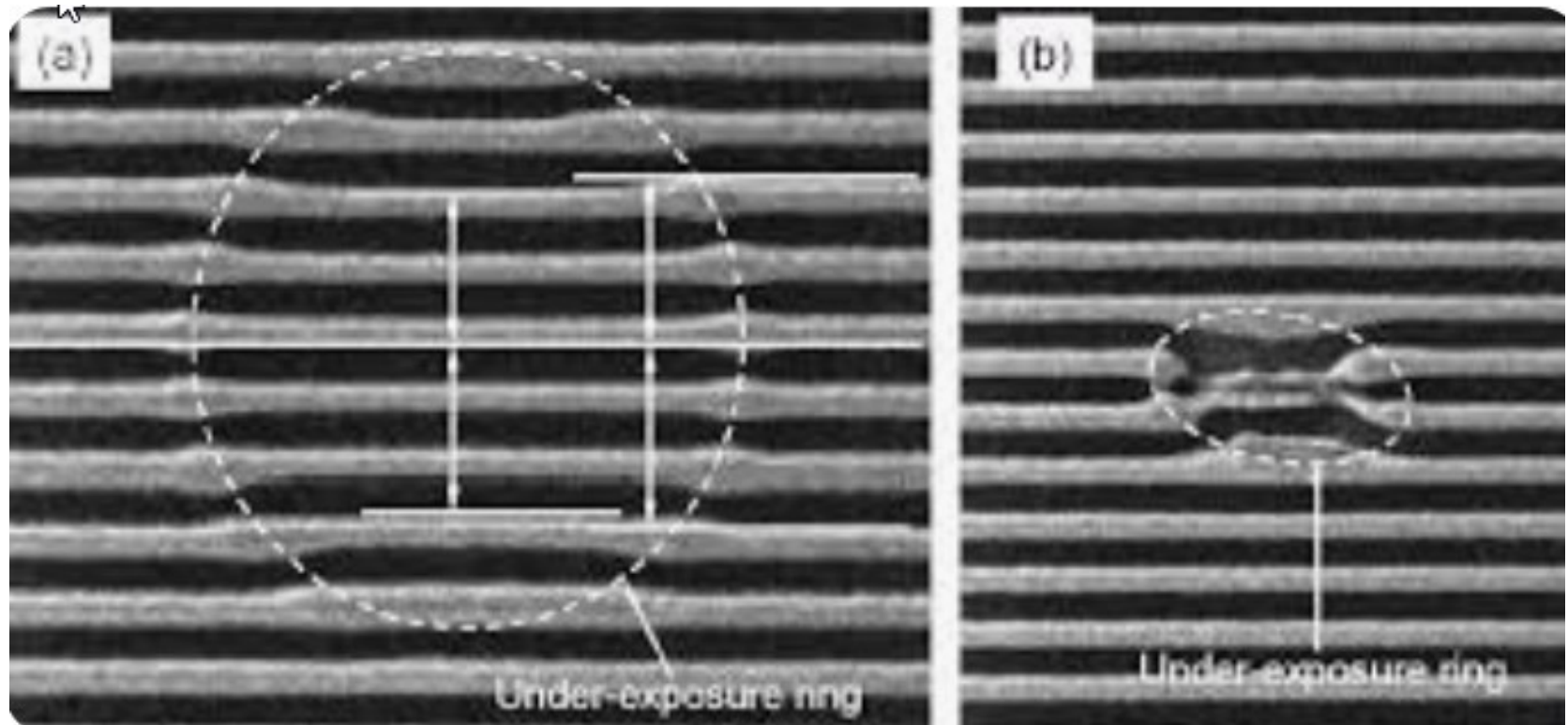

SEM Images of Irregularity and/or Defects

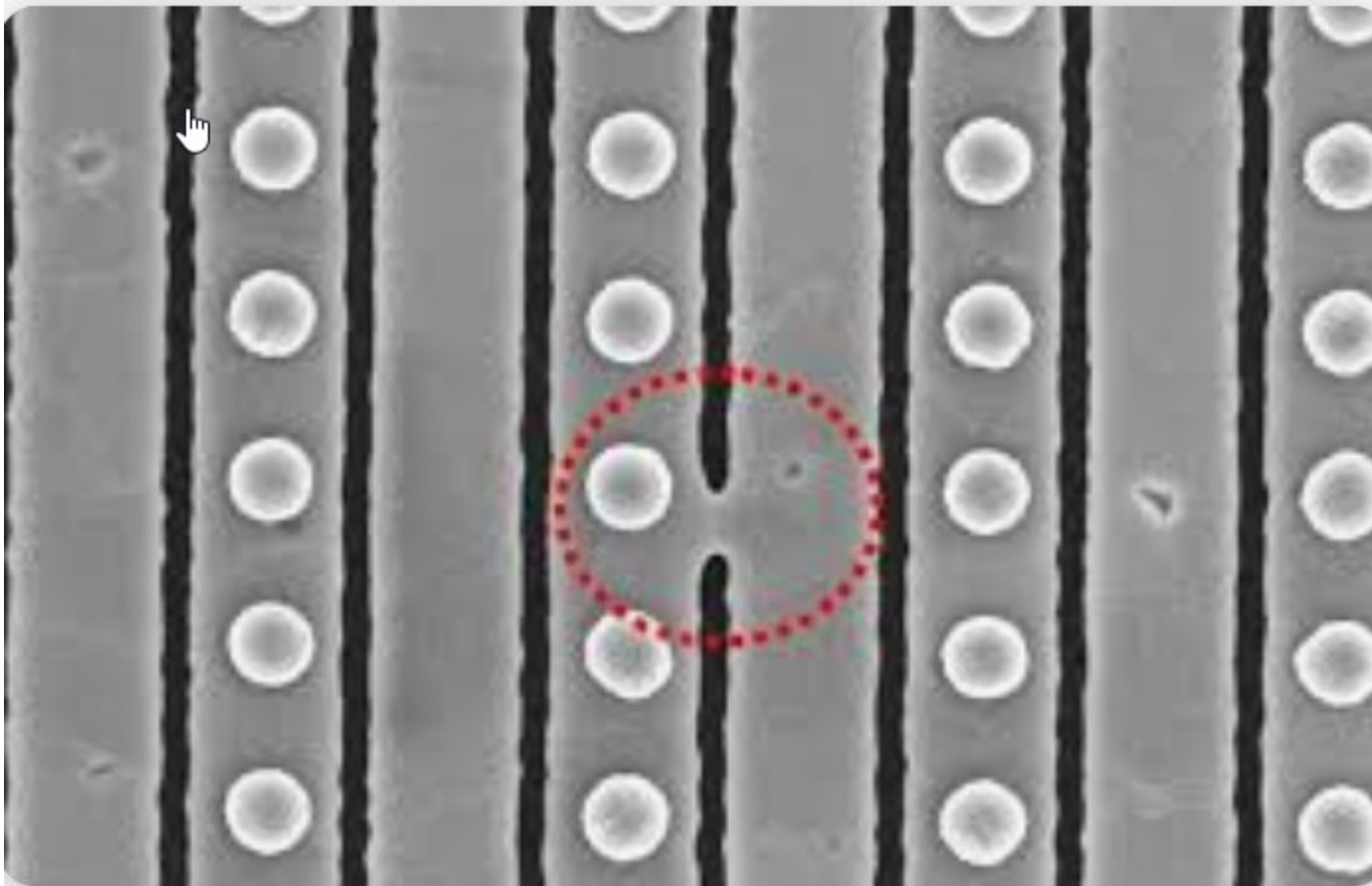

SEM Images of Irregularity and/or Defects

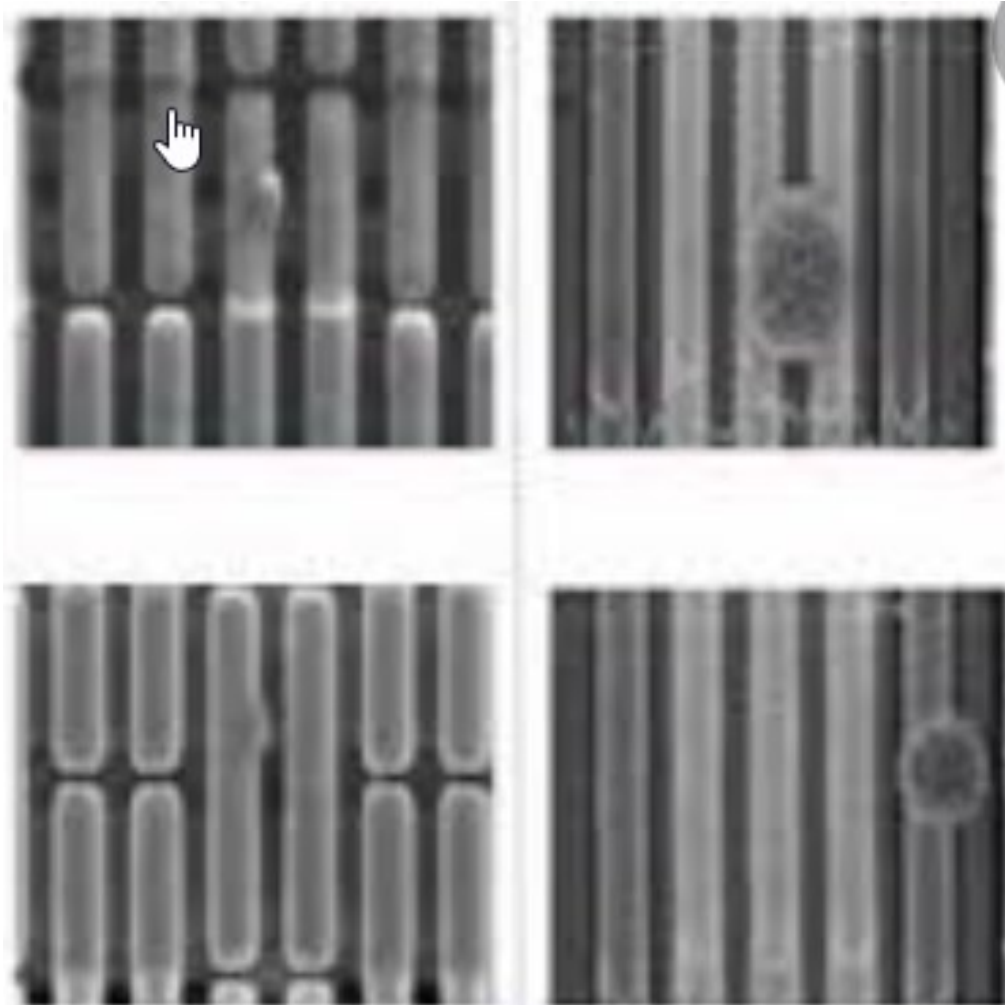

SEM Images of Irregularity and/or Defects

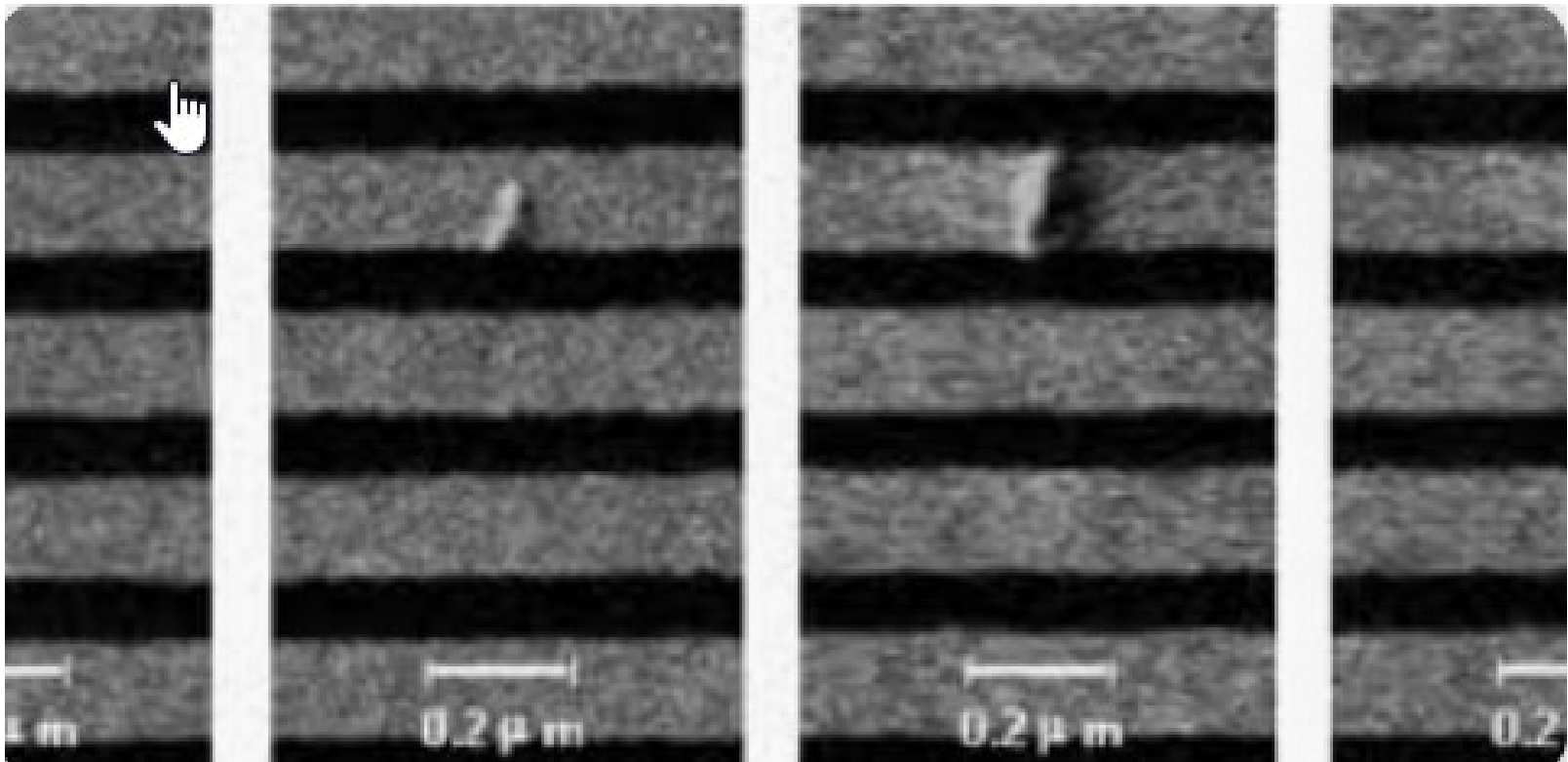

SEM Images of Irregularity and/or Defects

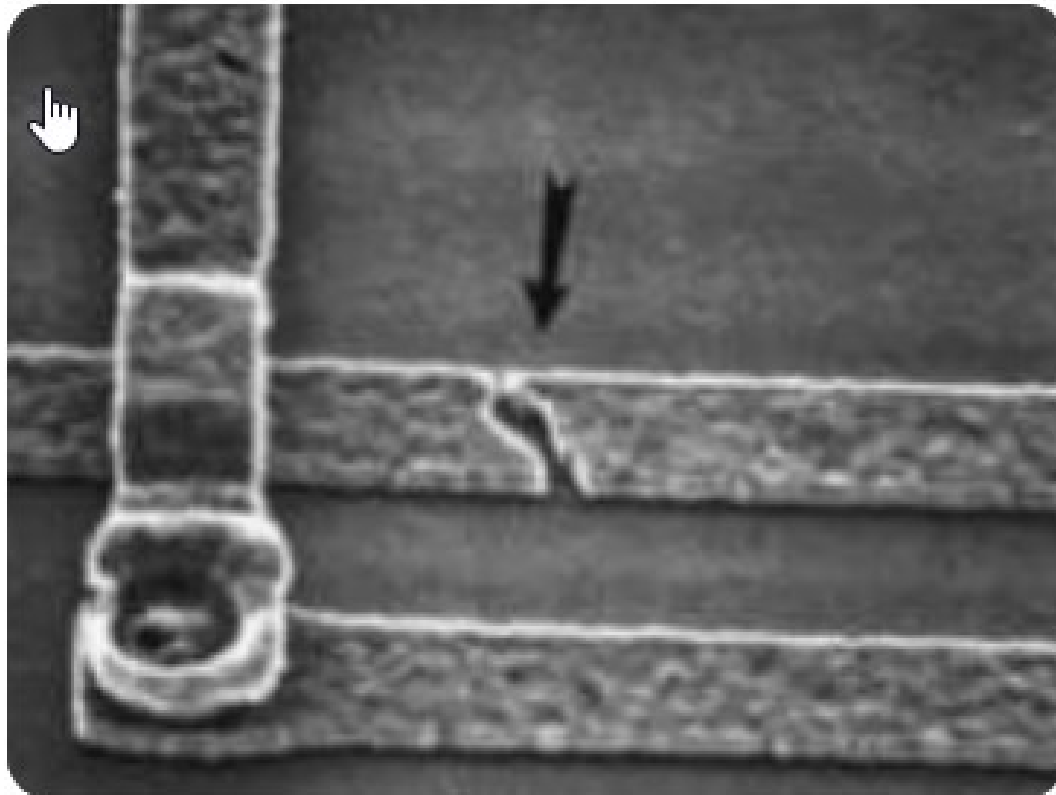

Semiconductor Electromigration In...

What is meant by “reliably”

Yield is acceptable if circuit performs as designed even when a very large number of these features are made

If P is the probability that a feature is good

n is the number of uncorrelated features on an IC

Y is the yield

$$Y = P^n$$

$$P = e^{\frac{\log_e Y}{n}}$$

Example: How reliable must a feature be?

$$n=5E3$$

$$Y=0.9$$

$$P = e^{-\frac{\log_e Y}{n}} = e^{-\frac{\log_e 0.9}{5E3}} = 0.999979$$

But is $n=5000$ large enough ?

is Y large enough?

More realistically $n=5E9$ (or even $5E10$)

Consider $n=5E9$

$$P = e^{-\frac{\log_e Y}{n}} = e^{-\frac{\log_e 0.9}{5E9}} = 0.999999999979$$

20 parts in a trillion or size of a piece of sheetrock relative to area of Iowa

Extremely high reliability must be achieved in all processing steps to obtain acceptable yields in state of the art processes

Feature Size

- Typically minimum length of a transistor
- Often minimum width or spacing of a metal interconnect (wire)
- Point of “bragging” by foundries
 - Drawn length and actual length differ
- Often specified in terms of pitch
 - Pitch is sum of feature size and spacing of same feature
 - Pitch approximately equal to twice minimum feature size

Feature Size Evolution

Mid 70's	25 μ
2005	90nm
2010	20nm
2020	7nm

$$1\mu = 10^3 \text{ nm} = 10^{-6} \text{ m} = 10^4 \text{ \AA}$$

Review from last lecture:

Field Effect Transistors

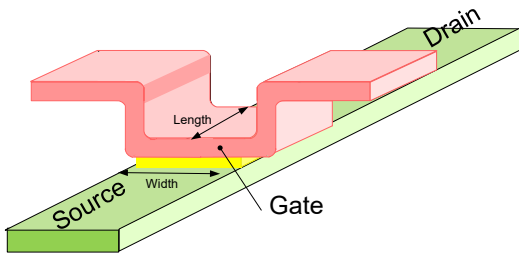

Planar MOSFET (LOCOS)

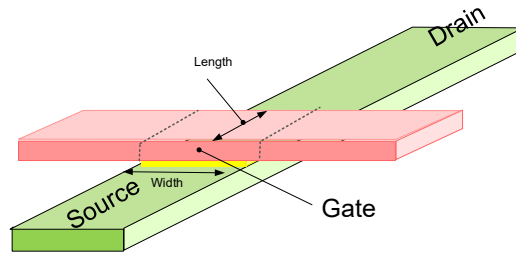

Planar MOSFET (STI)

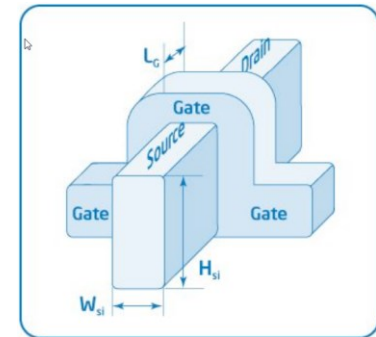

FinFET
Tri-Gate
Dielectric not shown

Planar MOS Transistor

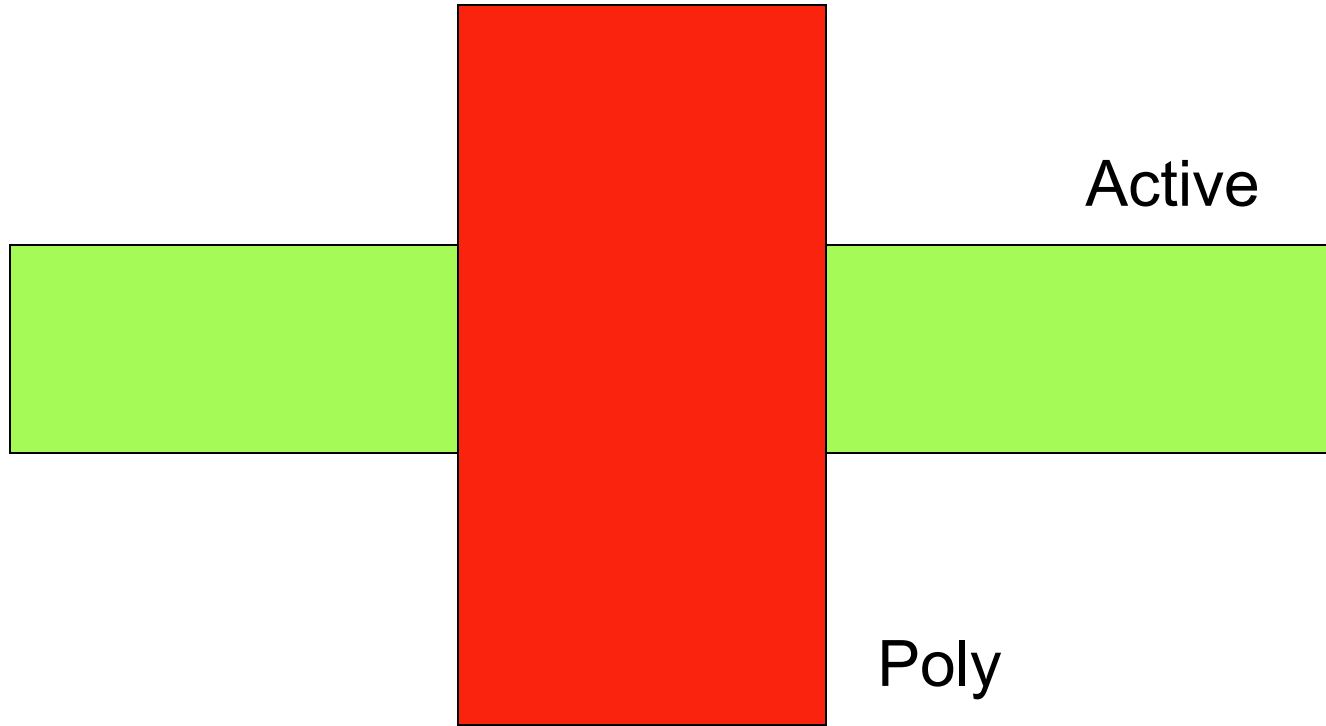

Planar MOS Transistor

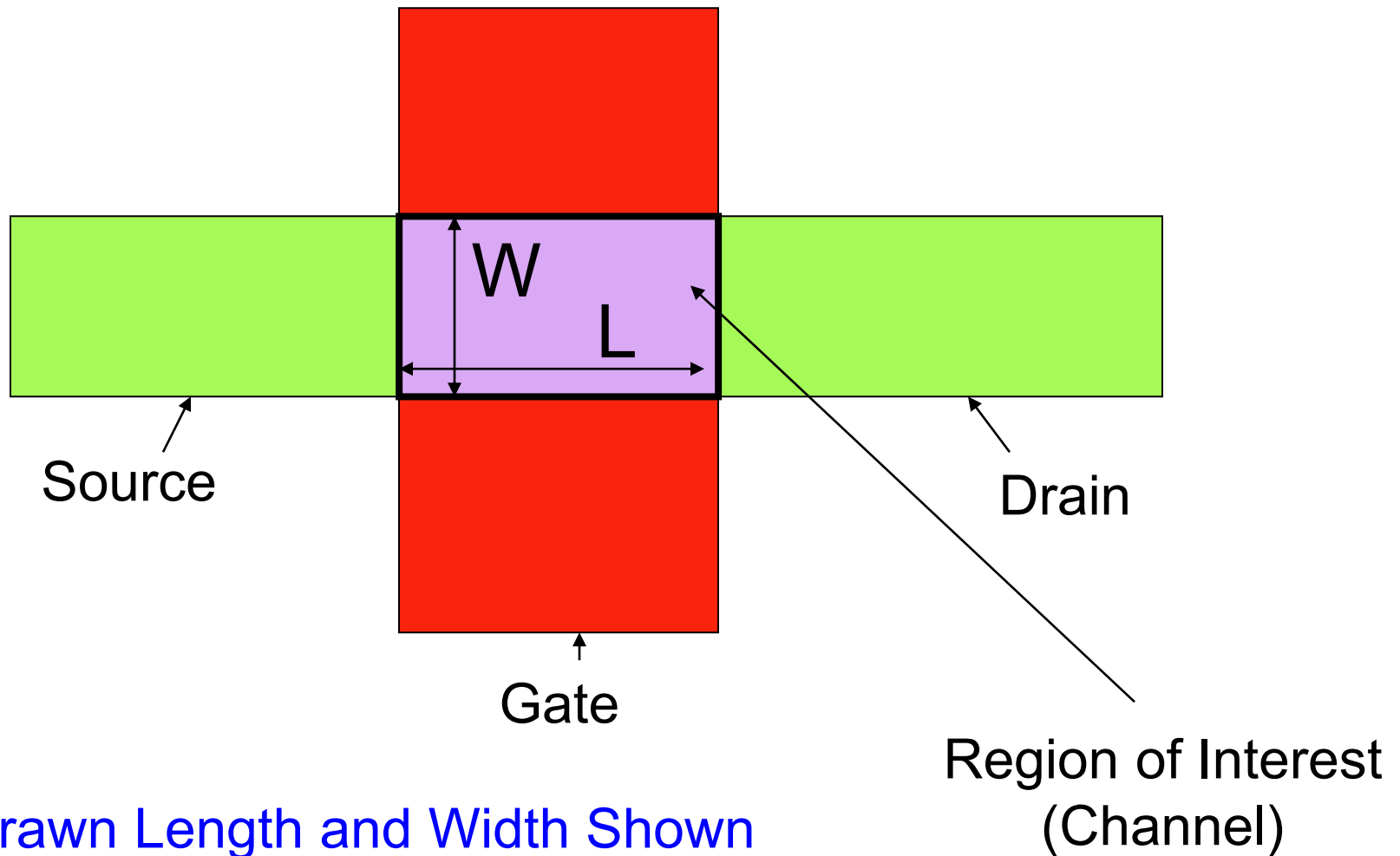

Henceforth, will assume planar devices unless specified to the contrary

MOS Transistor

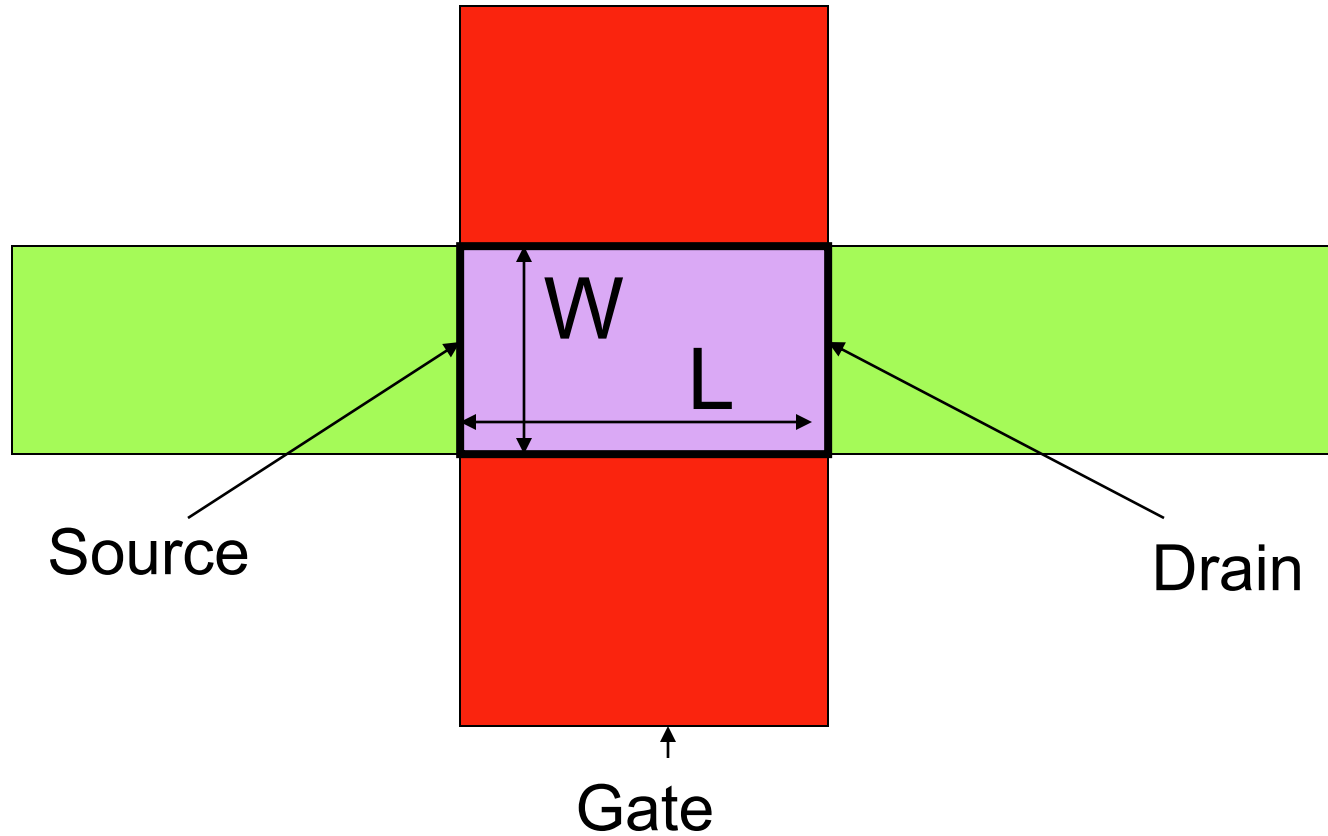

Actual Drain and Source at Edges of Channel

MOS Transistor

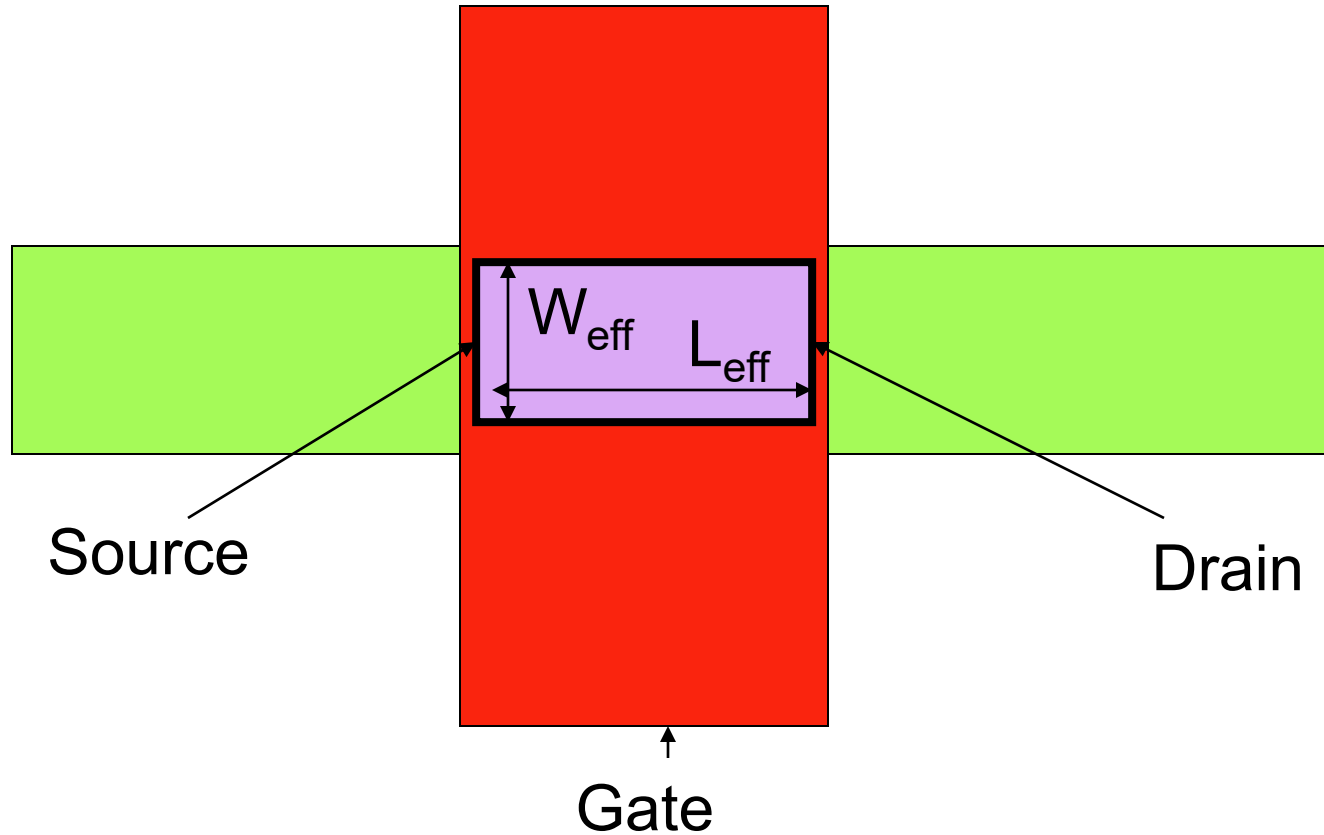

Effective Width and Length Generally
Smaller than Drawn Width and Length



Stay Safe and Stay Healthy !

End of Lecture 3